

# INSTALLATION INSTRUCTION

## ART:2475/3W ODEON LIGHT

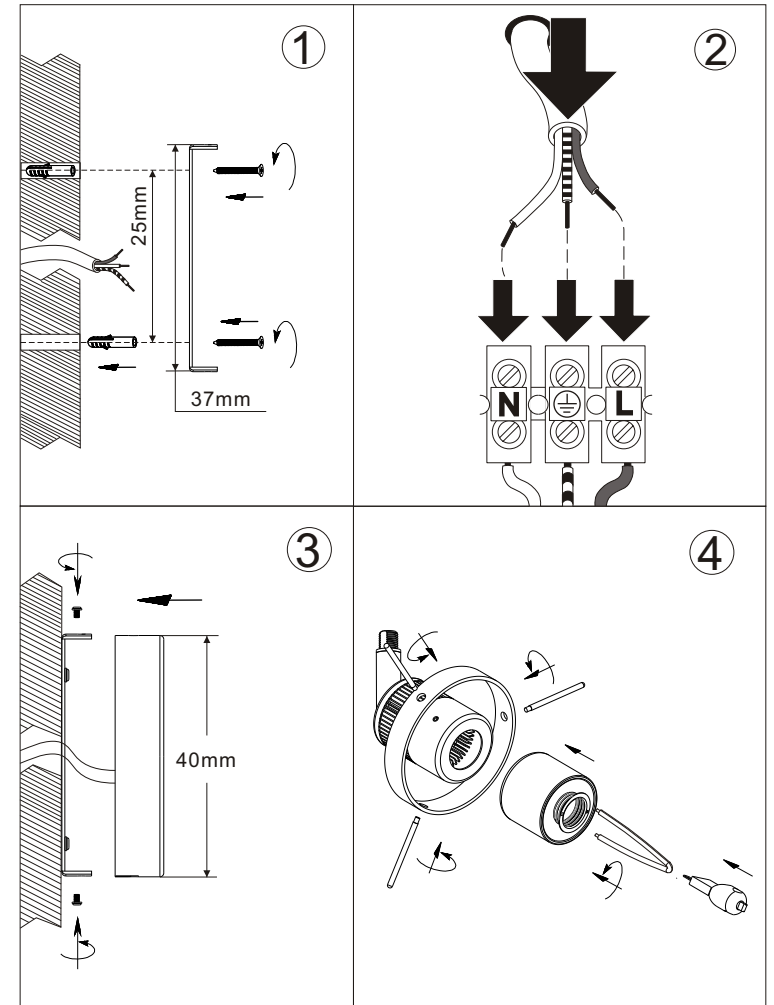
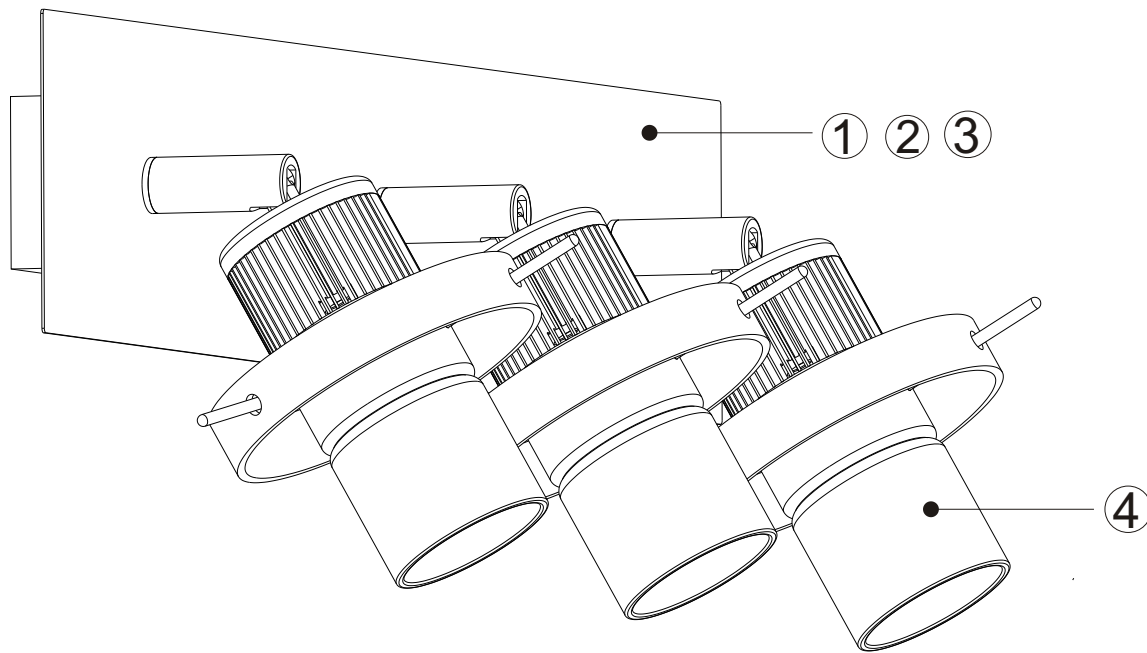

230V~50Hz G9 Max 3x40W