

### Specification of installation

In order to ensure safety use, please notice the following items:

.Read and understand the whole Specification.

.Suitable for the use of 220~240v and 50~60Hz.

.Please wear gloves as installment and avoid rot on the surface of plating.

.Must be installed on the fixed places and be checked annually.

.Please turn off the lighting source by soft cloth as cleaning prohibited to use of rotted detergent.

.Please connect with the local sales service centhr when there are any abnormality.

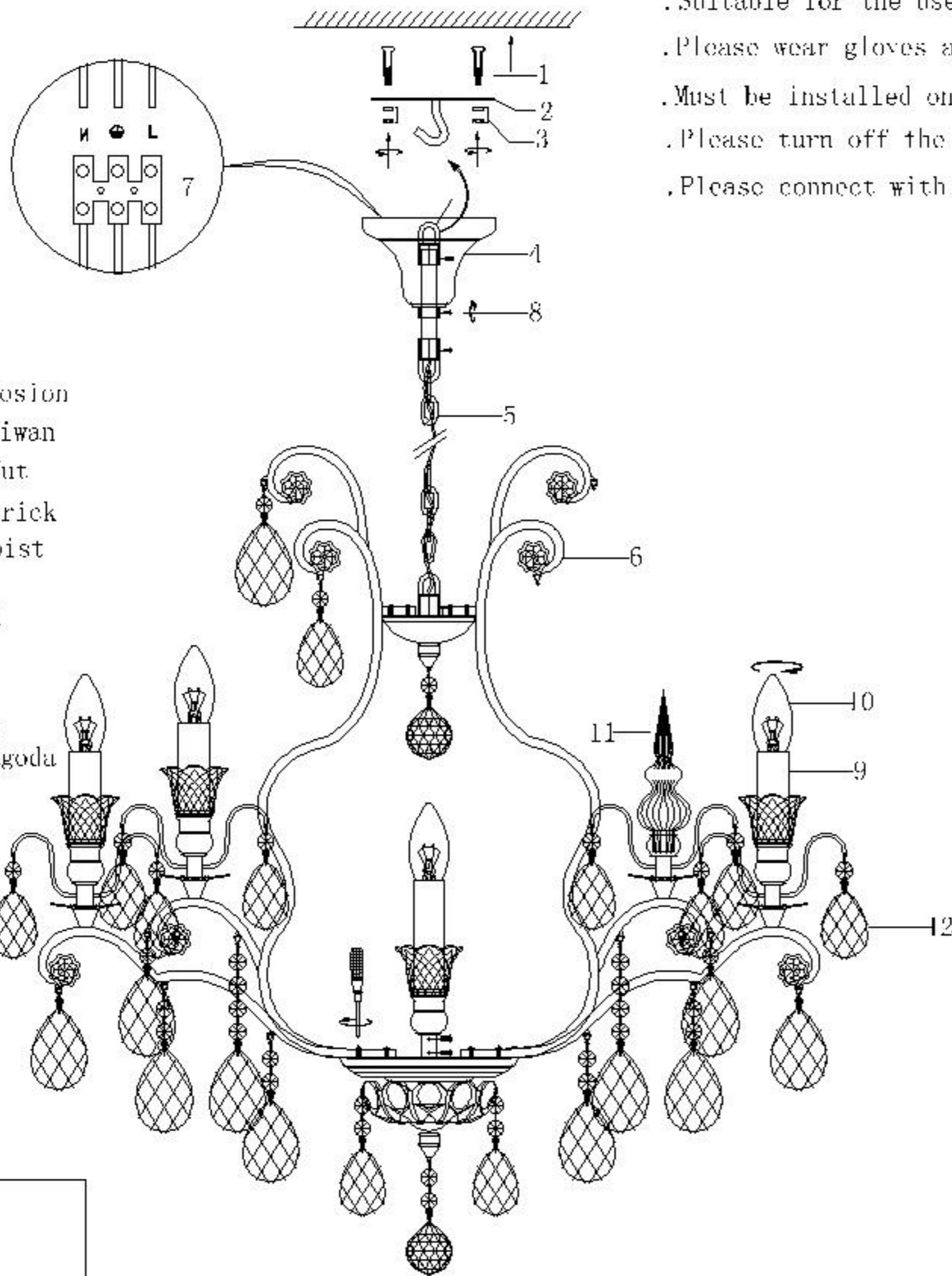

- 1: The explosion
- 2: Hangs Taiwan
- 3: Gasket, Nut
- 4: Bell, Derrick
- 5: Chain hoist
- 6: Lamp
- 7: Terminal
- 8: Screw
- 9: Casing
- 10: E11 bulb
- 11: Glass pagoda
- 12: Crystal

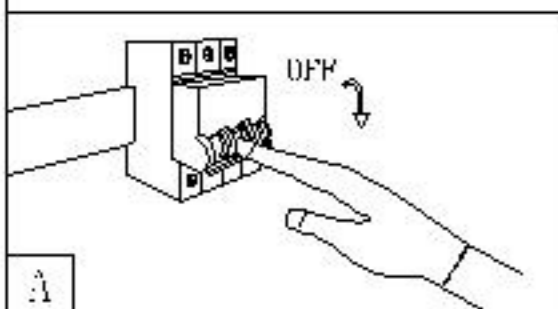

### CEILING PAN SIZE

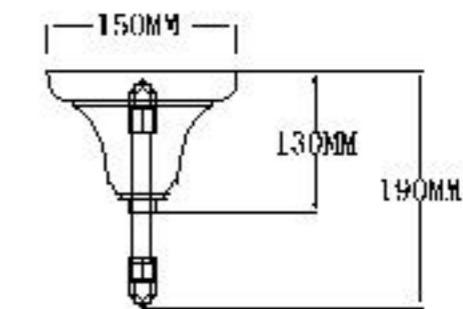



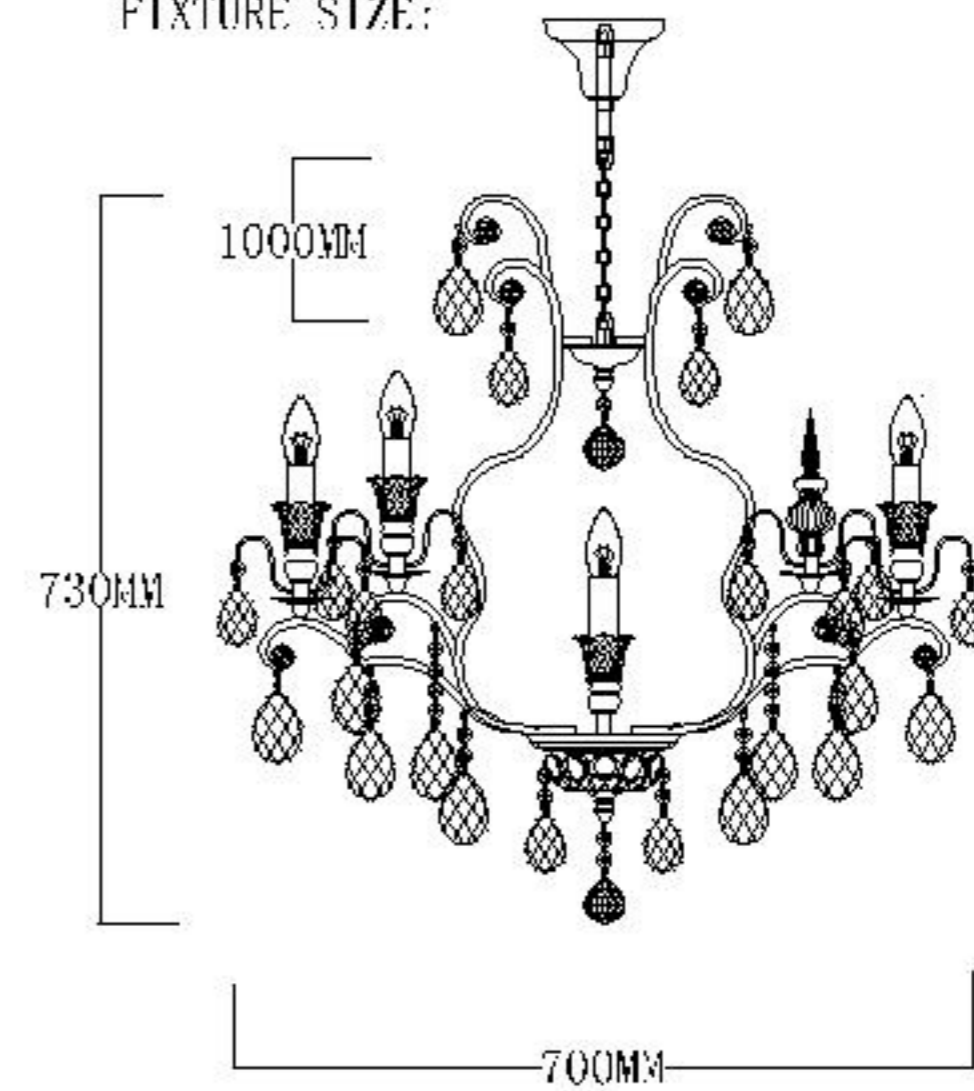



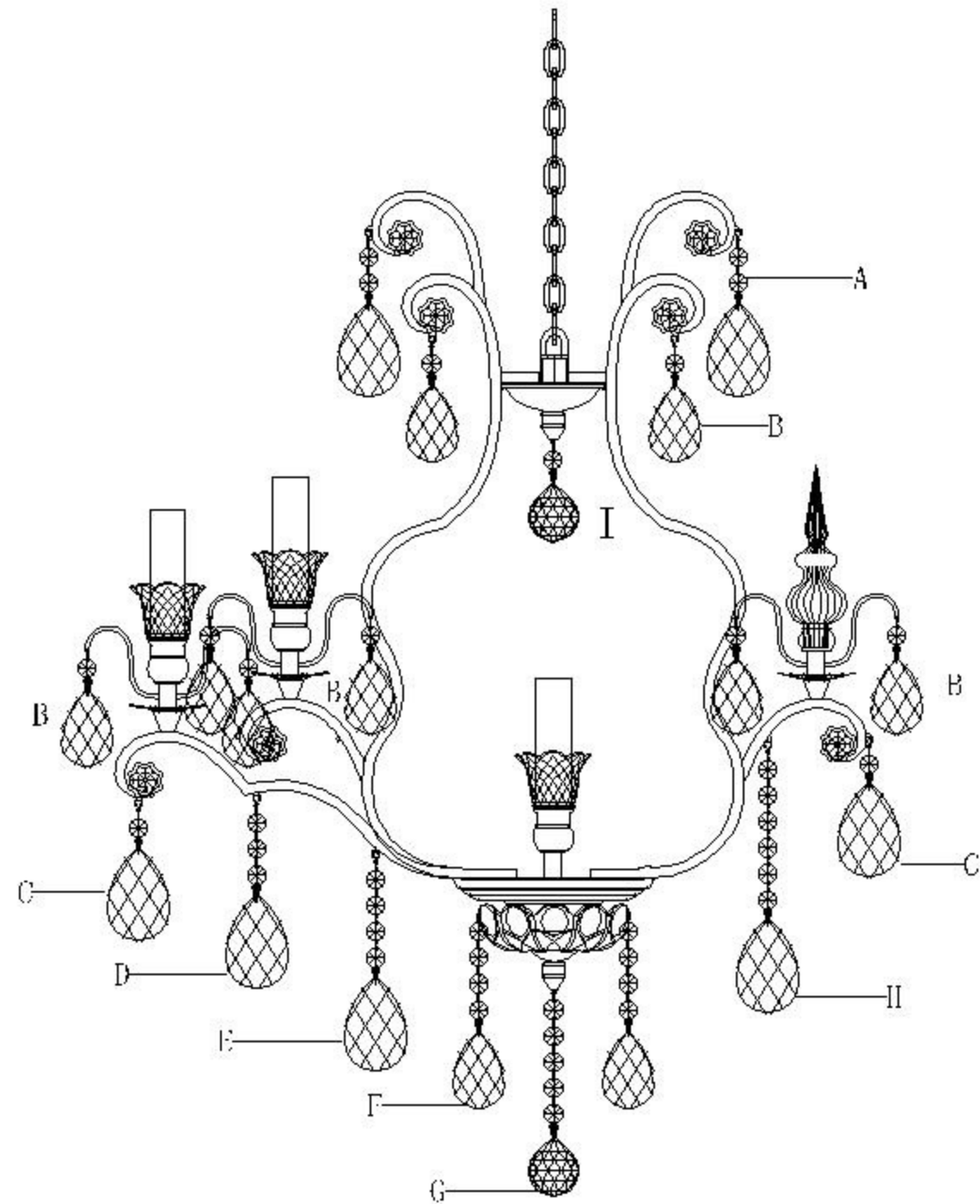
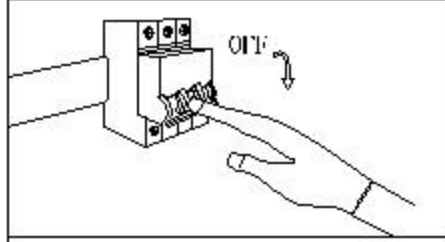

### FIXTURE SIZE:

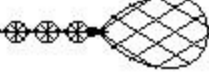

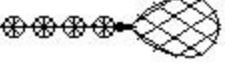
Product coding: MAGNIFICO SP13 BLACK/TRANSPARENT



A		14#/2+3"	8PCS
B		11#/1+2.5"	40PCS
C		14# 1-3"	16PCS
D		14#/3-3"	8PCS
E		14#/4-3"	8PCS
F		14#/4-2.5"	6PCS
G		14#/5+40#	1PCS
H		14#/6+3"	8PCS
I		14#/1+40#	1PCS