

Specification of installation

In order to ensure safety use, please notice the following items:

- Read and understand the whole Specification.
- Suitable for the use of 220~240V and 50~60Hz.
- Please wear gloves as installment and avoid rot on the surface of plating.
- Must be installed on the fixed places and be checked annually.
- Please turn off the lighting source by soft cloth as cleaning prohibited to use of rotted detergent.
- Please connect with the local sales service center when there are any abnormality.

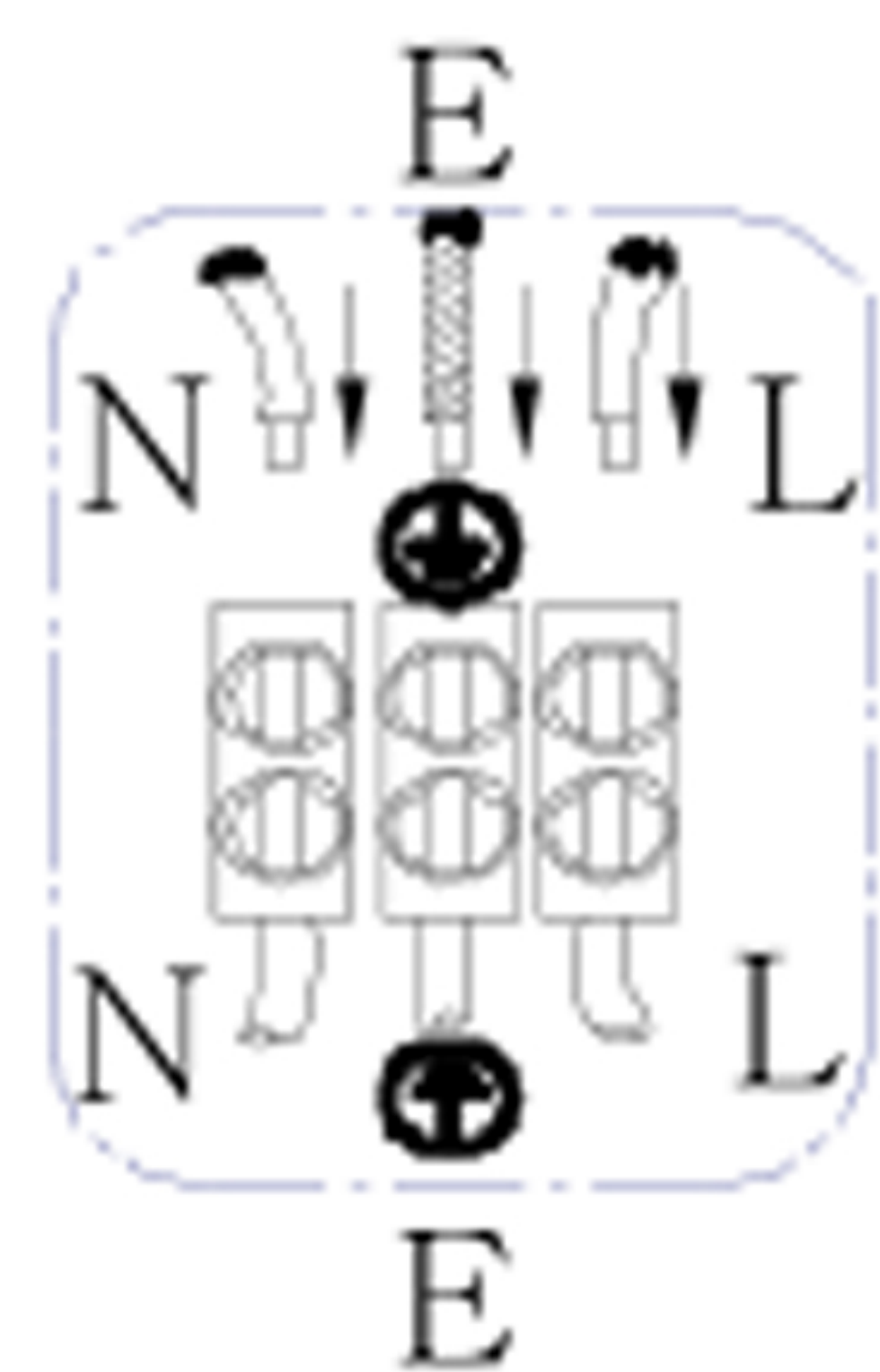

L = Brown Cable
 N = Blue Cable
 E = Yellow/Green Cable

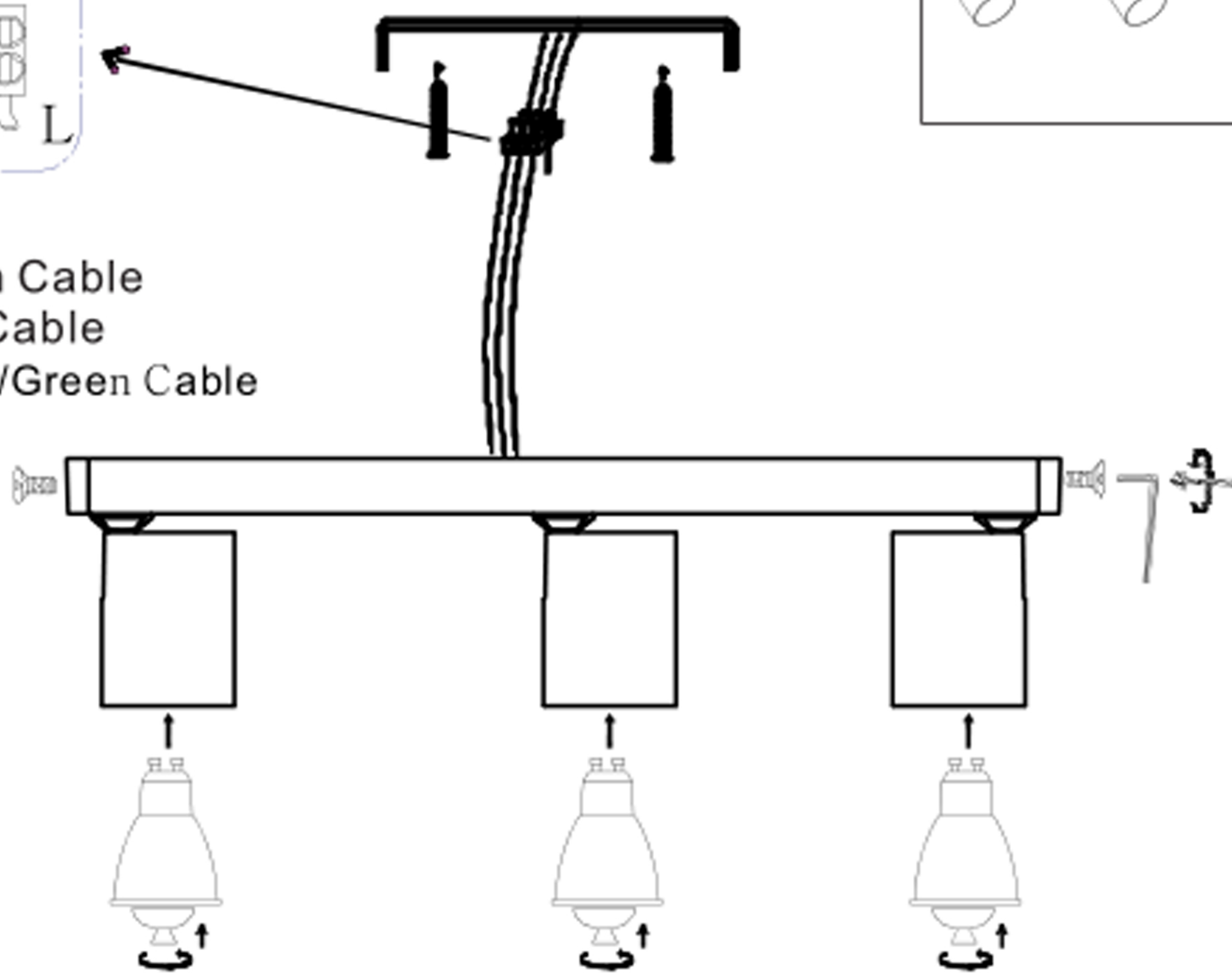
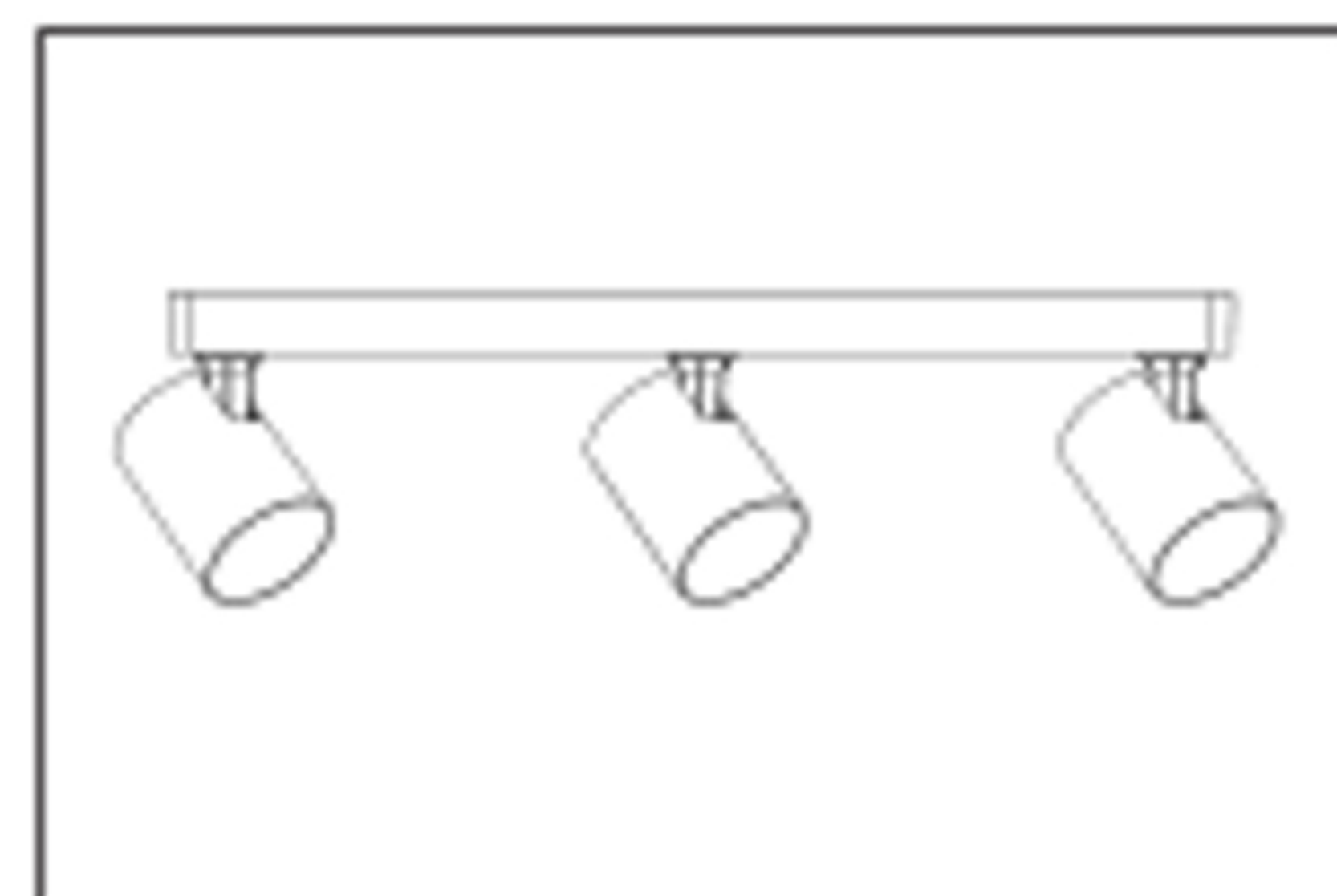

1. Bracket
2. Self-tapping screw
3. Terminal
4. Bulb

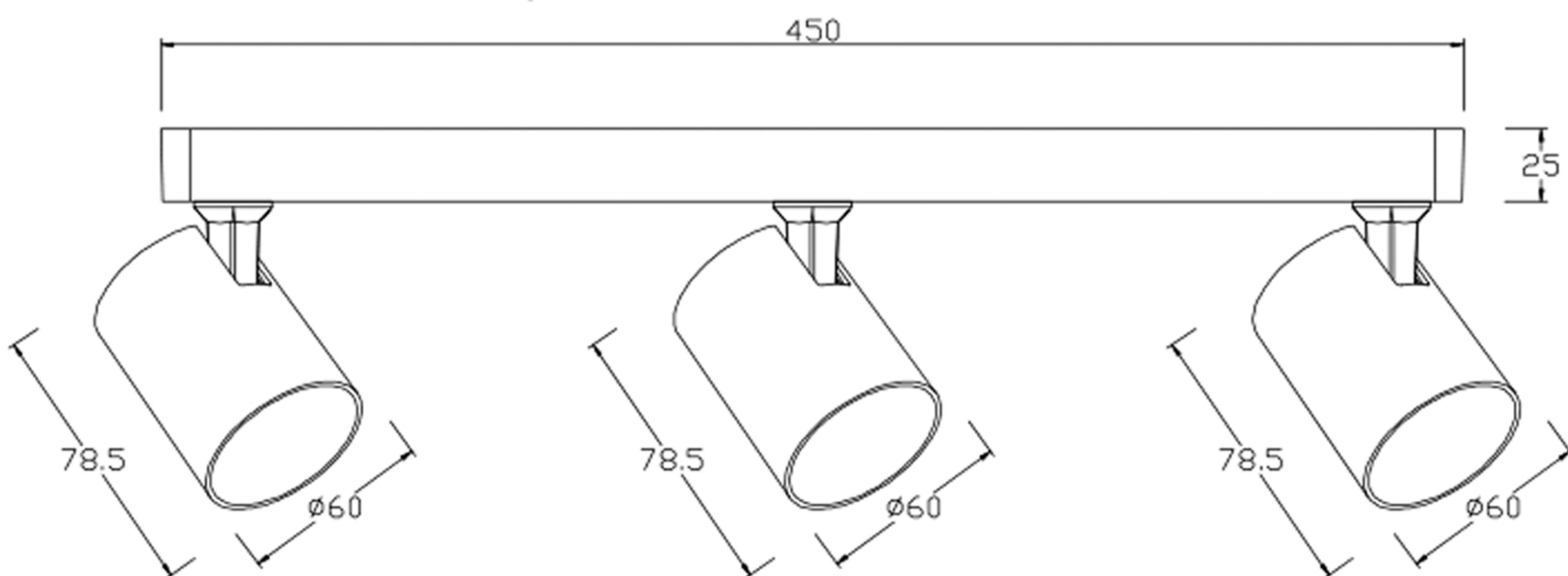

Input:220-240~50/60Hz Class I	IP20	
LAMP-HOUSE:GU10-35W(MAX.)		
MATERIAL:ALUMINUM		

INSTALLATION INSTRUCTION

- 1.Before installing,make sure the power supply is switched off.
- 2.Follow the steps as the figure for installation or replacement of bulb

Step:

- A.after holing,pull out the wires.
- B.fix the bracket to the wall with screws.
- C.connect the wires to the terminal block.
- D.fix the lamp body to the base with screws.
- E.insert the bulb with gasket to the lamp body.
- F.secure the bulb with lamp shade by twist in clockwise.

- 3.After finishing every step,tighten the screws,have the fixture fixed,and then connect the power supply.

CLEANING INSTRUCTION

- 1.Before cleaning,ensure that the power supply is switched off.
- 2.Use only a soft cloth to clean the lamp,dampened with mild cleanser if needed for resistant dirt.
- 3.Warning:do not use alcohol or other solvents.

CAUTION:

While the lamp is working,the surface of it is hot!

Please do not touch the fixture within an hour after the power supply has been switched off.

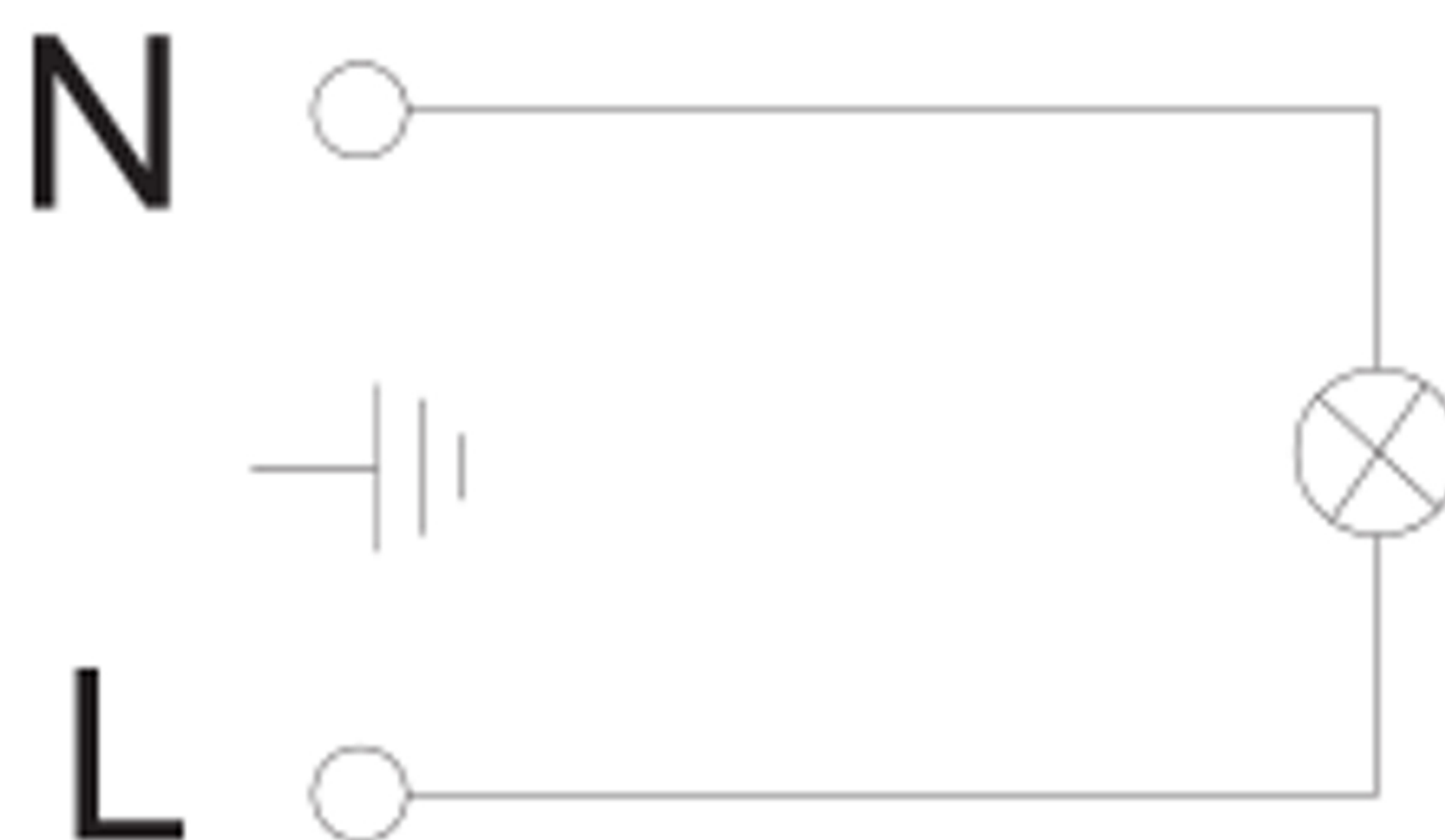

 CAUTION: WHILE THE LAMP IS WORKING, THE SURFACE OF IT IS VERY HOT, PLEASE DO NOT TOUCH!



1

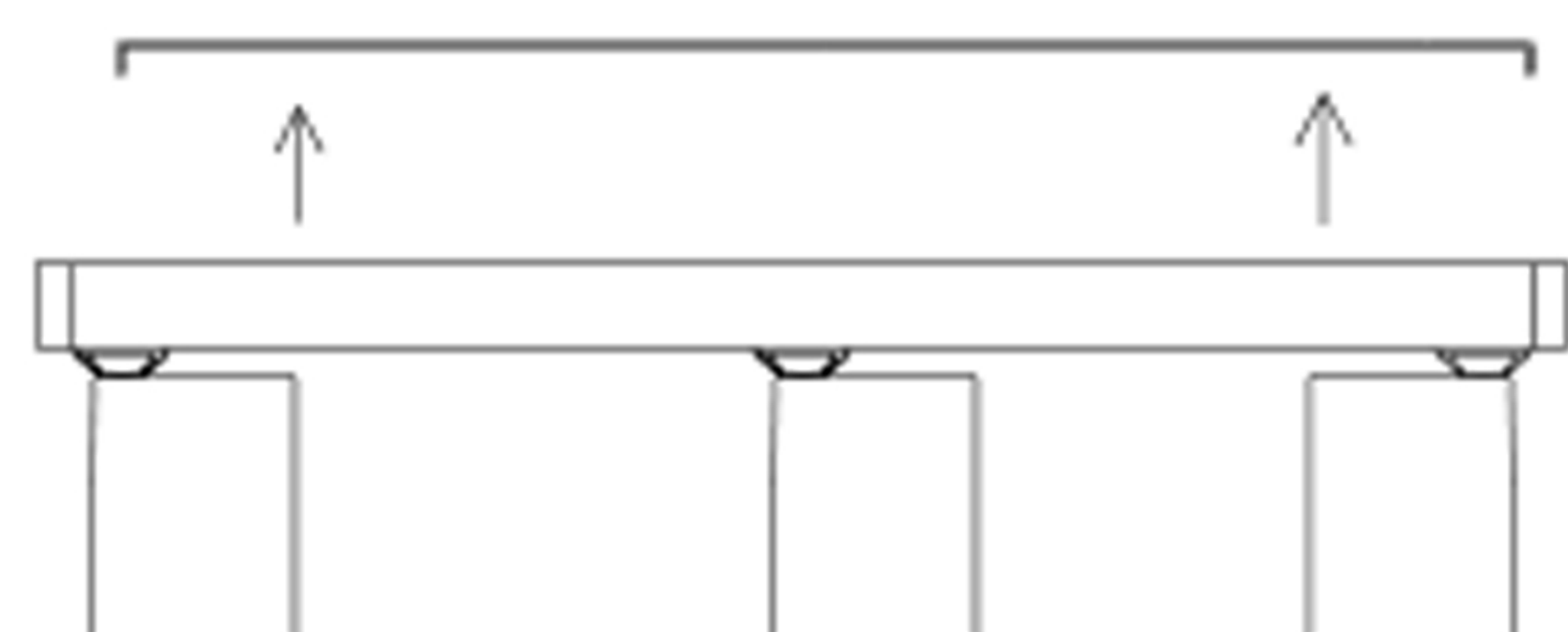

2



3

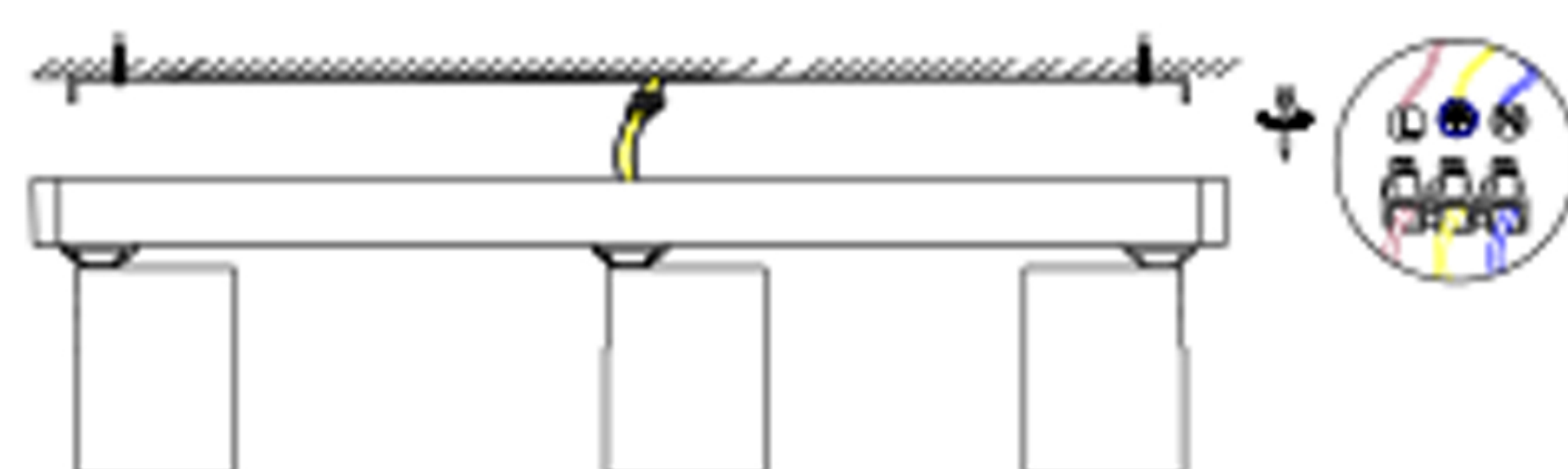

4

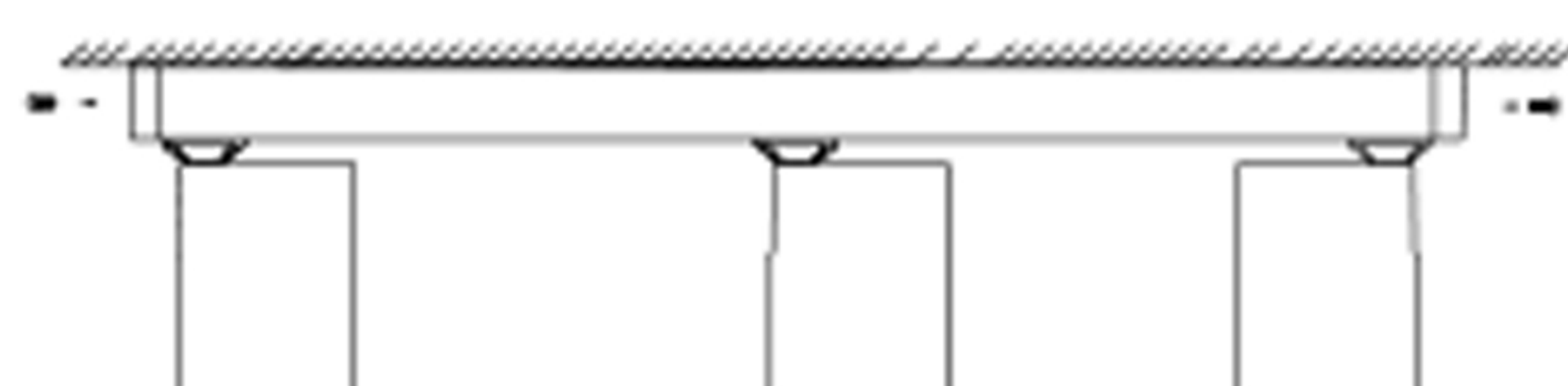

5

