

OFF

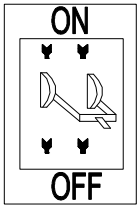

1

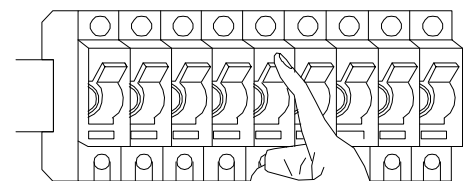
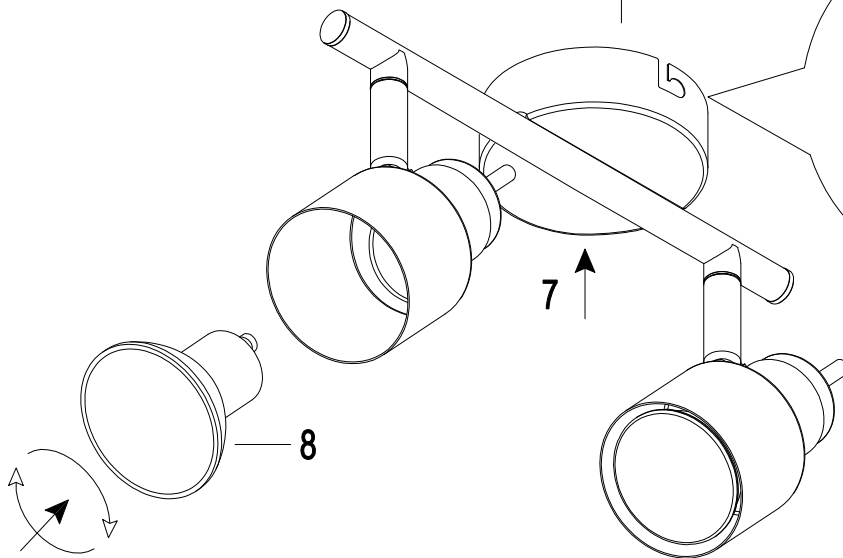
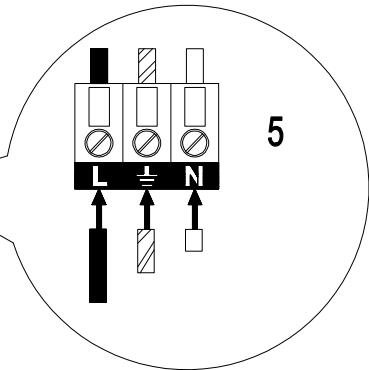
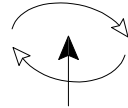
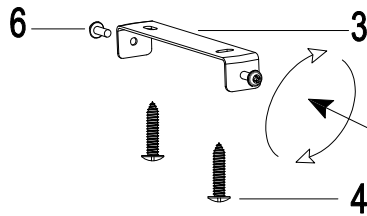
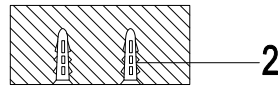

ON

9

